

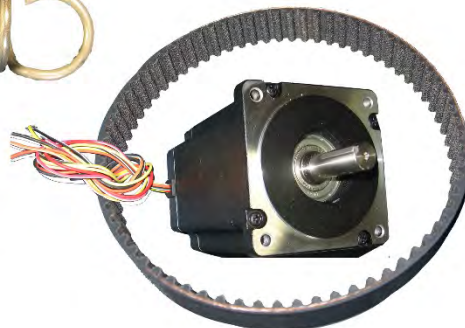









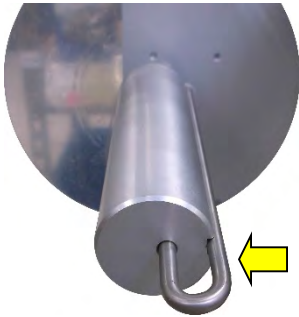

# 3015-ND/CE SPARE PARTS CATALOG



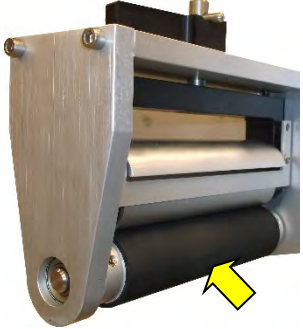

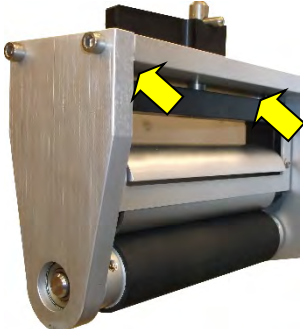

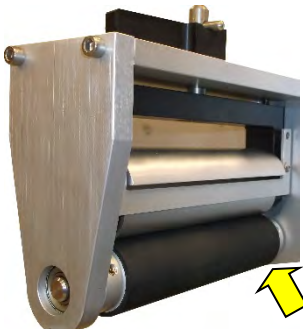
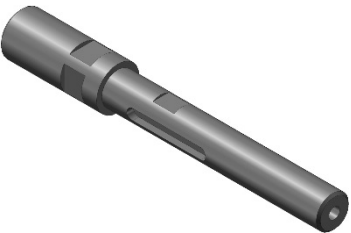

## LABEL-AIRE

<b>3015ND/CE SPARE PARTS WEAR ITEMS</b>					
NO	PART NO.	DESCRIPTION	QTY	ASSEMBLY PHOTO	DETAIL PHOTO
1	7440700SP	UNWIND BRAKE BAND	1		
2	7700254SP	UNWIND BRAKE SPRING	1		
3	7471761SP	PIN LOCKING RWD 6"	1		

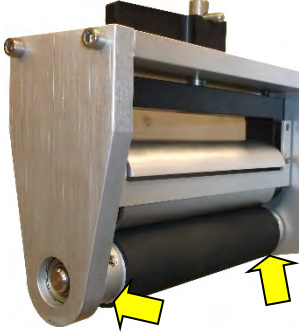
For parts pricing and availability, call QLC, Inc. (800) 837-1309

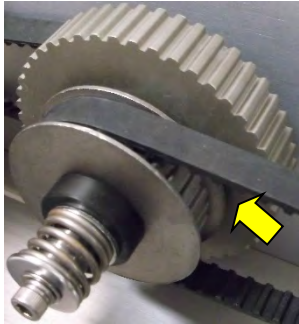
3015ND/CE SPARE PARTS WEAR ITEMS					
NO	PART NO.	DESCRIPTION	QTY	ASSEMBLY PHOTO	DETAIL PHOTO
4	7366131SP	ROLL DRIVE 6"	1		
5	7252902SP	PINCH ROLLER COMPRESSION SPRINGS	2		
6	3302281	SHAFT DRV ROLL	1		
7	3302278	SHAFT DRV ROLL EXTENSION	1		

For parts pricing and availability, call QLC, Inc. (800) 837-1309

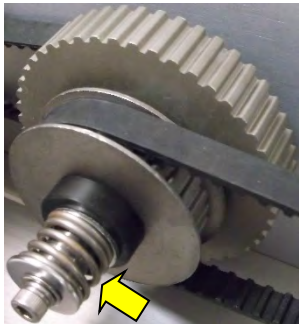
3015ND/CE SPARE PARTS WEAR ITEMS					
NO	PART NO.	DESCRIPTION	QTY	ASSEMBLY PHOTO	DETAIL PHOTO
8	7705773	BEARING	4		
9	3302276	SLIP CLUTCH DISK	2		
10	7701522SP	REWIND O-RING	2		
11	7700271AP	REWIND TENSION SPRING	1		





For parts pricing and availability, call QLC, Inc. (800) 837-1309

3015ND/CE SPARE PARTS WEAR ITEMS					
NO	PART NO.	DESCRIPTION	QTY	ASSEMBLY PHOTO	DETAIL PHOTO
12	3305862	DRIVE PULLEY	1		
13	3302274	CLUTCH PULLEY	1		
14	3302283	KEY	1		
15	3302282	BRG DELRN	1		

For parts pricing and availability, call QLC, Inc. (800) 837-1309

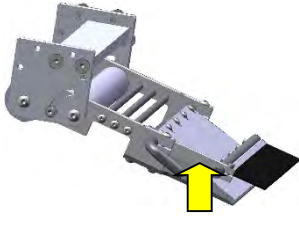
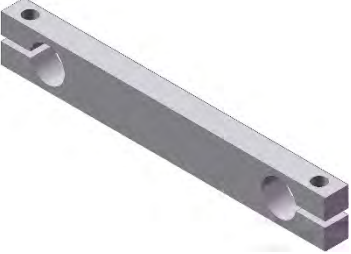
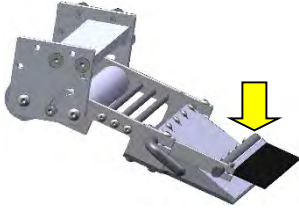
3015ND/CE SPARE PARTS WEAR ITEMS					
NO	PART NO.	DESCRIPTION	QTY	ASSEMBLY PHOTO	DETAIL PHOTO
16	7705772	BRG OIL	1		
17	7700746SP	DRIVE GEARBELT	1		
18	7431200SP	REWIND GEARBELT	1		
19	3306031	ASY P/B 7" RH/LH	1		
20	3301080SP	BRUSH 7" WIDE	1		

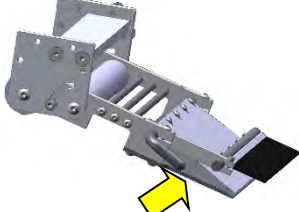
For parts pricing and availability, call QLC, Inc. (800) 837-1309

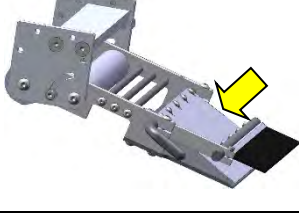
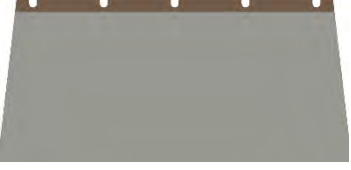
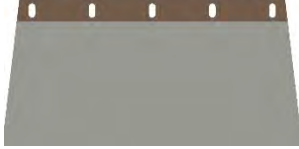
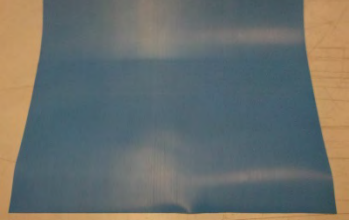
3015ND/CE SPARE PARTS WEAR ITEMS					
NO	PART NO.	DESCRIPTION	QTY	ASSEMBLY PHOTO	DETAIL PHOTO
21	3301079	BRACKET BRUSH MTG P/B	1		
22	3301075	SHAFT MTG BRUSH 7.0 P/B	1		
23	3301074SP	ASY PEELER PLT W/TAPE 7" SS	1		
24	3301076SP	ASY PLATE SPRING 7" W/TAPE	1		
25	7702883SP	P/B TAPE 8"WD .005"THK UHMW FILM	in		

For parts pricing and availability, call QLC, Inc. (800) 837-1309









**3015ND/CE SPARE PARTS  
CIRCUIT BOARDS & ELECTRICAL**

NO	PART NO.	DESCRIPTION	QTY	ASSEMBLY PHOTO	DETAIL PHOTO
26	9031285SP	CNCTR PWR IEC 6A FLTR 2 FUSE (FUSES NOT INCLUDED)	1		
27	9022421SP	FUSE 5A 120V 5X20MM TYPE T SLOBLO	2		
28	9022423SP	FUSE 3.15A 250V 5X20MM T SB (CE MACHINES ONLY)	2		
29	DN0021011	DECAL 120V AC ONLY	1		

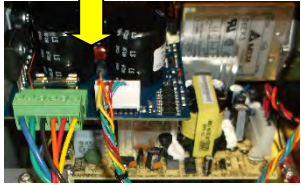
For parts pricing and availability, call QLC, Inc. (800) 837-1309

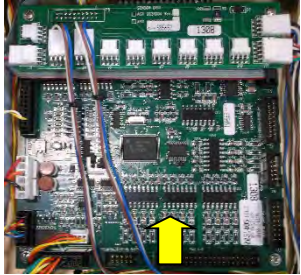

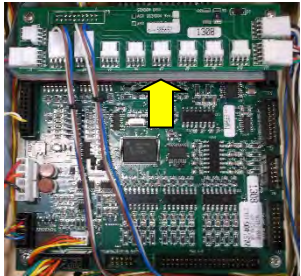
**3015ND/CE SPARE PARTS  
CIRCUIT BOARDS & ELECTRICAL**

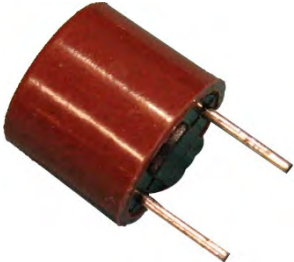
NO	PART NO.	DESCRIPTION	QTY	ASSEMBLY PHOTO	DETAIL PHOTO
30	DN0021012	DECAL 220V AC ONLY	1		
31	9020754SP	DRVR MTR STEPPER 6A A/A	1		
32	0031405SP	ASY PROCESSOR FUSED	1		
33	0031004	ASY SENSOR DISTRIBUTION BOARD WITH STATIC PROTECTION	1		
34	9022498	FUSE 24V 2 amp M/FUSE CONTROL BOARD LOCATION: F2	1		

For parts pricing and availability, call QLC, Inc. (800) 837-1309

3015ND/CE SPARE PARTS CIRCUIT BOARDS & ELECTRICAL					
NO	PART NO.	DESCRIPTION	QTY	ASSEMBLY PHOTO	DETAIL PHOTO
35	9022496	FUSE 5V 1amp SB M/FUSE CONTROL BOARD LOCATION: F1	1		
36	9000109	BATTERY CR2032 3.0V	1		
37	9000430AP	PWR SPLY REG SWITCHER 24V/5V	1		
38	7701133SP	FAN 115V 22 CFM	1	 	
39	3305868	DISPLAY ASSEMBLY	1		









For parts pricing and availability, call QLC, Inc. (800) 837-1309

3015ND/CE SPARE PARTS CIRCUIT BOARDS & ELECTRICAL					
NO	PART NO.	DESCRIPTION	QTY	ASSEMBLY PHOTO	DETAIL PHOTO
40	9051904	TERMNL BLOCK 6 POS PHOENIX	1		
41	7600005802 AP	SENS RETRO 10- 30VDC RED	1		
42	0031057SP	ASY/WRNG LOW LABEL	1		
43	3301387SP	ASY/WRNG STANDARD LBL SNSR	1		
44	9020755SP	STEPPER MOTOR ASSEMBLY	1		

For parts pricing and availability, call QLC, Inc. (800) 837-1309







3015ND/CE SPARE PARTS CIRCUIT BOARDS & ELECTRICAL					
NO	PART NO.	DESCRIPTION	QTY	ASSEMBLY PHOTO	DETAIL PHOTO
45	9001214	TOROID XFMR 115/230 - 100V 250VA (CE MACHINES ONLY)	1		
46	7701356	LGT STK 50MM REPLACEMENT LAMP	3		
47	7701353	LGT STK 50MM GRN MOD STDY	1		

For parts pricing and availability, call QLC, Inc. (800) 837-1309

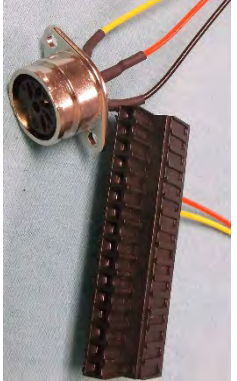

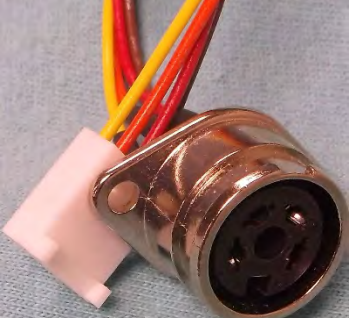
3015ND/CE SPARE PARTS CIRCUIT BOARDS & ELECTRICAL					
NO	PART NO.	DESCRIPTION	QTY	ASSEMBLY PHOTO	DETAIL PHOTO
48	7701355	LGT STK 50MM AMBER MOD STDY	1		
49	7701354	LGT STK 50MM RED MOD STDY	1		
50	3305864	ELECTRONICS TRAY	1		
51	7465517	CABLE APPL PORT DATAMAX/SA	1		

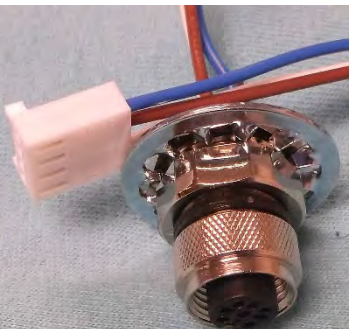
For parts pricing and availability, call QLC, Inc. (800) 837-1309

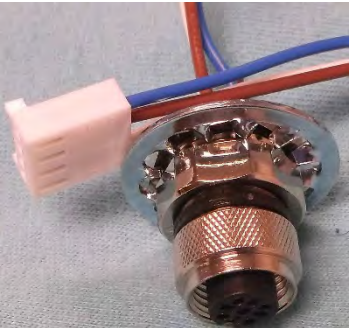

**3015ND/CE SPARE PARTS  
CIRCUIT BOARDS & ELECTRICAL**

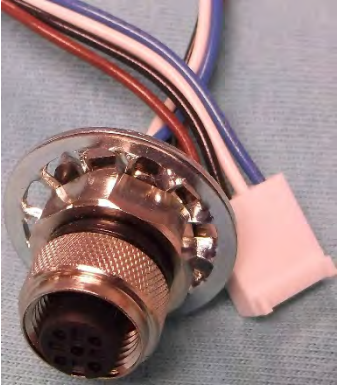
NO	PART NO.	DESCRIPTION	QTY	ASSEMBLY PHOTO	DETAIL PHOTO
52	0031401	IMPRINTER CABLE	1		
53	0031400	ENCODER CABLE	1		
54	0031398	LABEL OUT CABLE	1		
55	0031398	LABEL LOW CABLE	1		

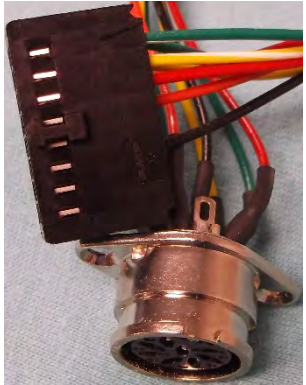
For parts pricing and availability, call QLC, Inc. (800) 837-1309





3015ND/CE SPARE PARTS CIRCUIT BOARDS & ELECTRICAL					
NO	PART NO.	DESCRIPTION	QTY	ASSEMBLY PHOTO	DETAIL PHOTO
56	0031397	PROD DET CABLE	1		
57	0031403	STROBE CABLE	1		

For parts pricing and availability, call QLC, Inc. (800) 837-1309

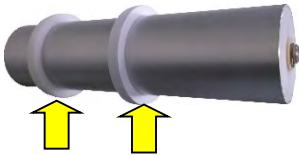
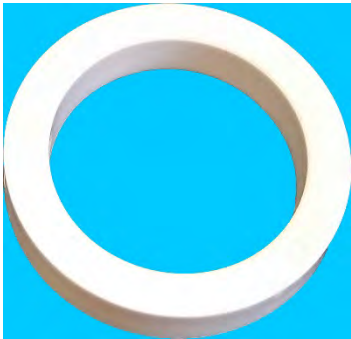
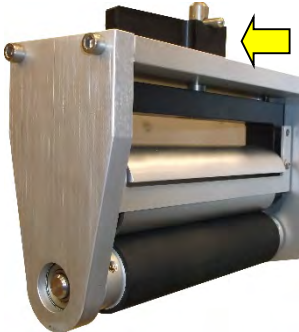

3015ND/CE SPARE PARTS MECHANICAL PARTS					
NO	PART NO.	DESCRIPTION	QTY	ASSEMBLY PHOTO	DETAIL PHOTO
58	7700951AP	RETRO PRODUCT DETECTOR REFLECTOR TAPE	1		
59	3302354	ASY PLATE UNWD OUTER 12" OD	1		
60	3302307	ASY DISK UNWD INNER 12" OD	1		
61	3303008	ASY ROLLER 2.00 X 6.87 SE CLR (DANCER)	1		
62	3302320	RING WEB GUIDE 1.13"DIA ROL (P/B COLLAR)	2		

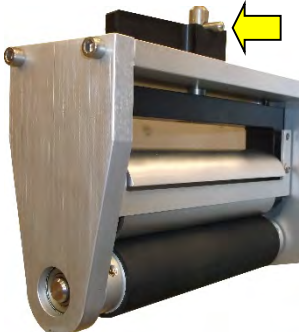
For parts pricing and availability, call QLC, Inc. (800) 837-1309

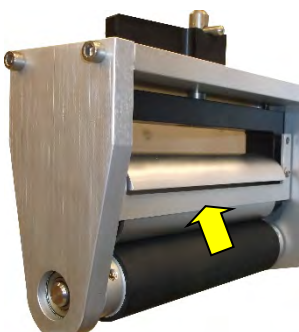
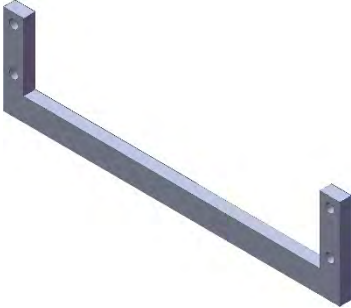

3015ND/CE SPARE PARTS MECHANICAL PARTS					
NO	PART NO.	DESCRIPTION	QTY	ASSEMBLY PHOTO	DETAIL PHOTO
63	7212010	COLLAR GUIDE (2" DIA ROLLER)	2		
64	7366030	CAM PINCH ROLLER	1		
65	7366310	PIN CAM PINCH ROLL	1		
66	3302348	GUARD PINCH ROLLER	2		

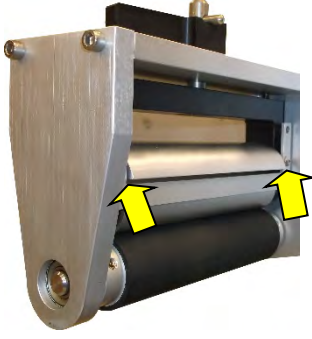
For parts pricing and availability, call QLC, Inc. (800) 837-1309

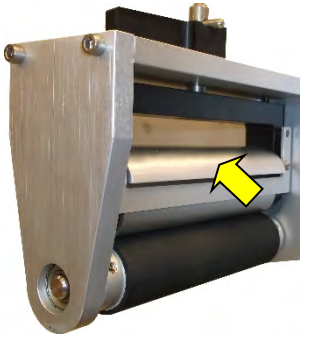
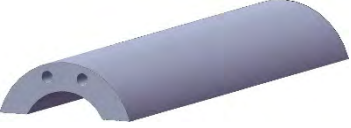
3015ND/CE SPARE PARTS MECHANICAL PARTS					
NO	PART NO.	DESCRIPTION	QTY	ASSEMBLY PHOTO	DETAIL PHOTO
67	7366145	SPACER MTG PINCH GUARD	4		
68	3302352	WEB GUIDE	1		

For parts pricing and availability, call QLC, Inc. (800) 837-1309