

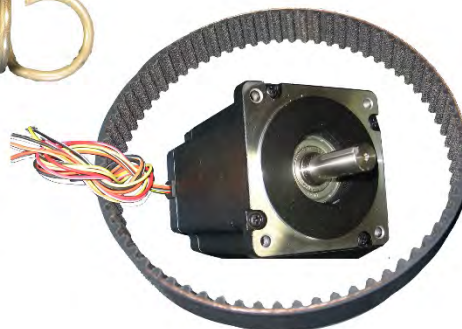







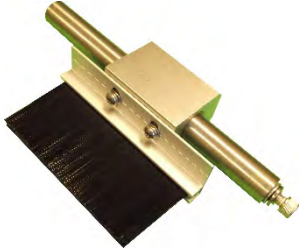

3111-NV/CE SPARE PARTS CATALOG

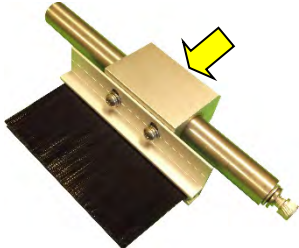
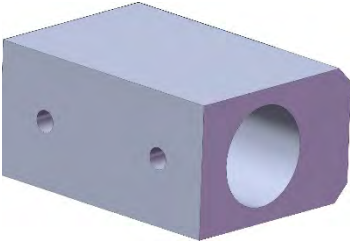

LABEL-AIRE

3111NV/CE SPARE PARTS WEAR ITEMS					
NO	PART NO.	DESCRIPTION	QTY	ASSEMBLY PHOTO	DETAIL PHOTO
1	3306170	ASY MAIN DRIVE 7"	1		
2	3301177SP	ASY ROLLER DRIVE 7" W/SET SCREWS	1		
3	3301440SP	ASY PINCH ROLL MAIN DRIVE 7"	1		
4	7707428SP	SPRING COMPRESSION NIP ROLLER .240X1.00X39.98 #IN	4		
5	3301130SP	WEB TENSION BRUSH 4" ASSEMBLY	1		



For parts pricing and availability, call QLC, Inc. (800) 837-1309

3111NV/CE SPARE PARTS WEAR ITEMS					
NO	PART NO.	DESCRIPTION	QTY	ASSEMBLY PHOTO	DETAIL PHOTO
6	3301135SP	WEB TENSION BRUSH 4" W/BRACKET	1		
7	3301137	WEB TENSION BRUSH 4"	1		
8	3301131	WEB TENSION BLOCK	1		
9	3306185SP	ASY BRAKE BAND	1		
10	7702330SP	SPRING EXT .500X2.00X17.30 #IN	1		
11	T916110	ANCHOR SPRING 1/4-20 X 1.375	1		

For parts pricing and availability, call QLC, Inc. (800) 837-1309

3111NV/CE SPARE PARTS WEAR ITEMS					
NO	PART NO.	DESCRIPTION	QTY	ASSEMBLY PHOTO	DETAIL PHOTO
12	7703040	KNOB REWIND ADJUSTMENT	2		
13	3306172	DISK SLIP CLUTCH	2		
14	7707469	SPRING CMP .660X1.00X40.1 #IN	1		
15	7701532SP	O-RING SLIP CLUTCH 1.500X 1.750X0.125 BUNA	2		
16	7702159SP	MAIN DRIVE GEARBELT HTD 350-5M-15	1		

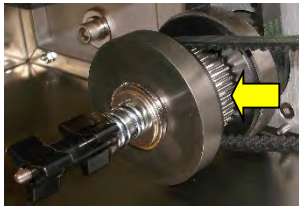

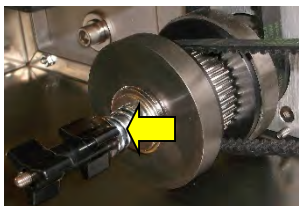
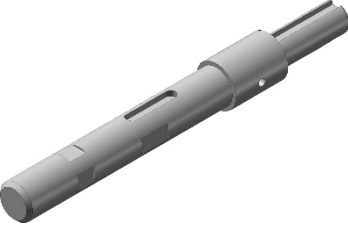
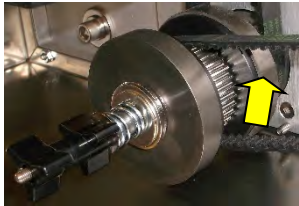
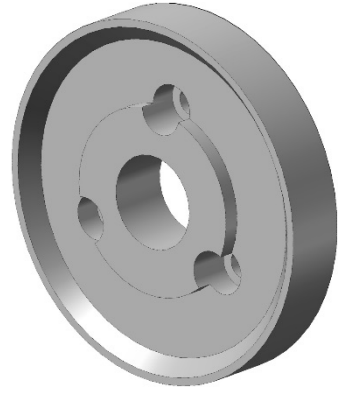
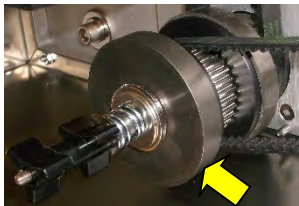
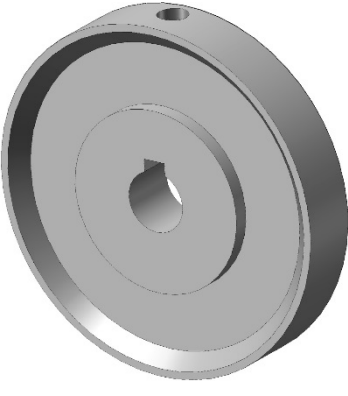
For parts pricing and availability, call QLC, Inc. (800) 837-1309

3111NV/CE SPARE PARTS WEAR ITEMS					
NO	PART NO.	DESCRIPTION	QTY	ASSEMBLY PHOTO	DETAIL PHOTO
17	7210200	ASY PULLEY MAIN DRIVE WITH BEARING	1		
18	3306177SP	ASY SHAFT DRIVE ROLLER (WITH RACE)	1		
19	3306179	SPACER SLP/CLUTCH	1		
20	3306173	SPACER SLP/CL PRESSURE	1		

For parts pricing and availability, call QLC, Inc. (800) 837-1309

3111NV/CE SPARE PARTS WEAR ITEMS					
NO	PART NO.	DESCRIPTION	QTY	ASSEMBLY PHOTO	DETAIL PHOTO
21	3303019	KEY	1		
22	7702847SP	REWIND GEARBELT HTD 500-5M-09	1		
23	3303298	P/B TIP 7" HRD 0.025R	1		
24	3302054SP	ASY H/DN BLK 4"&7" P/B	1		

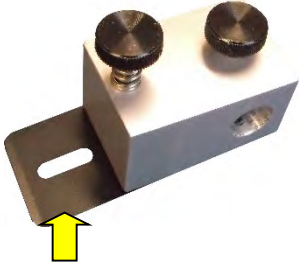
For parts pricing and availability, call QLC, Inc. (800) 837-1309

3111NV/CE SPARE PARTS WEAR ITEMS					
NO	PART NO.	DESCRIPTION	QTY	ASSEMBLY PHOTO	DETAIL PHOTO
25	7422701	SPRING P/B H/DN HRD TIP	1		

For parts pricing and availability, call QLC, Inc. (800) 837-1309

**3111NV/CE SPARE PARTS
CIRCUIT BOARDS & ELECTRICAL**







NO	PART NO.	DESCRIPTION	QTY	ASSEMBLY PHOTO	DETAIL PHOTO
26	9031285SP	CNCTR PWR IEC 6A FLTR 2 FUSE (FUSES NOT INLUDED)	1		
27	9022421SP	FUSE 5A 120V 5X20MM TYPE T SLOBLO	2		
28	9022423SP	FUSE 3.15A 250V 5X20MM T SB (CE MACHINES ONLY)	2		
29	DN0021011	DECAL 120V AC ONLY	1		

For parts pricing and availability, call QLC, Inc. (800) 837-1309

**3111NV/CE SPARE PARTS
CIRCUIT BOARDS & ELECTRICAL**

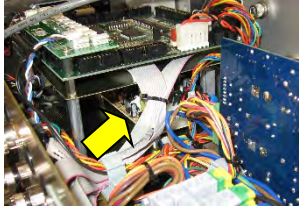
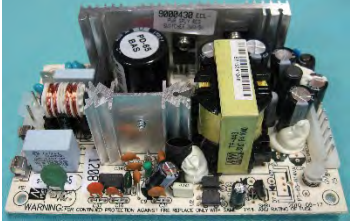
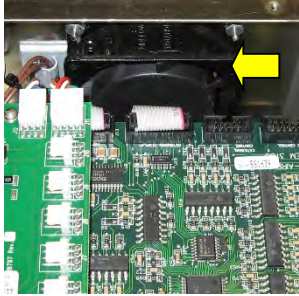
NO	PART NO.	DESCRIPTION	QTY	ASSEMBLY PHOTO	DETAIL PHOTO
30	DN0021012	DECAL 220V AC ONLY	1		
31	9020754SP	DRVR MTR STEPPER 6A A/A	1		
32	7703161	DRVR MTR STEPPER 6A MDX (CE MACHINES ONLY)	1		
33	0031230SP	ASY PROCESSOR FUSED	1		
34	0031004	ASY SENSOR DISTRIBUTION BOARD WITH STATIC PROTECTION	1		
35	9022498	FUSE 24V 2 amp M/FUSE CONTROL BOARD LOCATION: F2	1		

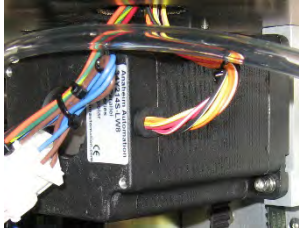
For parts pricing and availability, call QLC, Inc. (800) 837-1309







3111NV/CE SPARE PARTS CIRCUIT BOARDS & ELECTRICAL					
NO	PART NO.	DESCRIPTION	QTY	ASSEMBLY PHOTO	DETAIL PHOTO
36	9022496	FUSE 5V 1amp SB M/FUSE CONTROL BOARD LOCATION: F1	1		
37	9000109	BATTERY CR2032 3.0V	1		
38	9000430AP	PWR SPLY REG SWITCHER 24V/5V	1		
39	7701133SP	FAN 115V 22 CFM	2		
40	7702427SP	MTR STEP NEMA 34 FRAME 2 STACK	1		

For parts pricing and availability, call QLC, Inc. (800) 837-1309

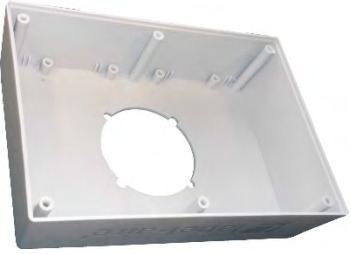
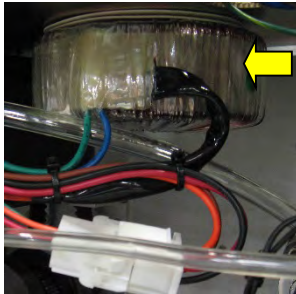
3111NV/CE SPARE PARTS CIRCUIT BOARDS & ELECTRICAL					
NO	PART NO.	DESCRIPTION	QTY	ASSEMBLY PHOTO	DETAIL PHOTO
41	9051904	TERMNL BLOCK 6 POS PHOENIX	1		
42	7600005802 AP	SENS RETRO 10- 30VDC RED	1		
43	0031057SP	ASY/WRNG LOW LABEL	1		
44	3301387SP	ASY/WRNG STANDARD LBL SNSR	1		
45	3305080SP	ASY DISPLAY CNTRL PANEL (INCLUDES KEYPAD, DISPLAY, BOARD & CABLE)	1		

For parts pricing and availability, call QLC, Inc. (800) 837-1309

**3111NV/CE SPARE PARTS
CIRCUIT BOARDS & ELECTRICAL**

NO	PART NO.	DESCRIPTION	QTY	ASSEMBLY PHOTO	DETAIL PHOTO
46	3306247	DISPLAY CONTROL BOX	1		
47	9001214	TOROID XFMR 115/230 - 100V 250VA (CE MACHINES ONLY)	1		
48	7701356	LGT STK 50MM REPLACEMENT LAMP	3		
49	7701353	LGT STK 50MM GRN MOD STDY	1		

**3111NV/CE SPARE PARTS
CIRCUIT BOARDS & ELECTRICAL**





NO	PART NO.	DESCRIPTION	QTY	ASSEMBLY PHOTO	DETAIL PHOTO
50	7701355	LGT STK 50MM AMBER MOD STDY	1		
51	7701354	LGT STK 50MM RED MOD STDY	1		
52	0031021	ASY/WRNG CBL STROBE OUT	1		
53	0031017	ASY/WRNG CBL LABEL DET	1		

For parts pricing and availability, call QLC, Inc. (800) 837-1309



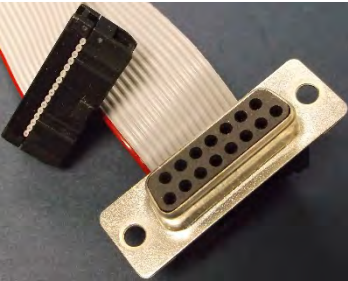

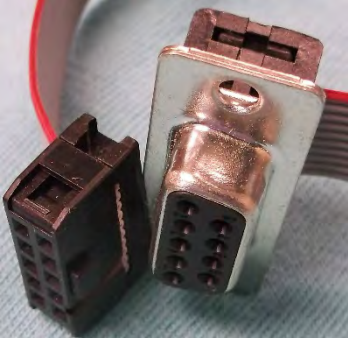

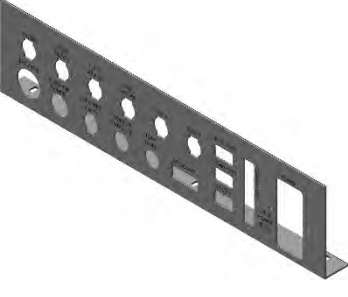

**3111NV/CE SPARE PARTS
CIRCUIT BOARDS & ELECTRICAL**

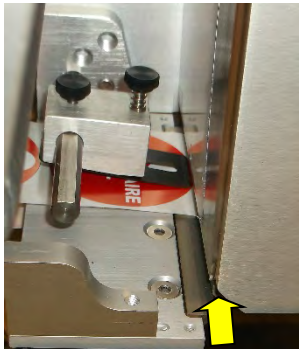
NO	PART NO.	DESCRIPTION	QTY	ASSEMBLY PHOTO	DETAIL PHOTO
54	7465517	CABLE APPL PORT DATAMAX/SA	1		
55	0031015	ASY/WRNG CBL ENCDR	1		
56	0030875SP	ASY/WRNG IMPRNT VLV INTL	1		
57	0031016	ASY/WRNG CBL PROD DET	1		
58	0031029	ASY/WRNG CBL LOW LABEL	1		

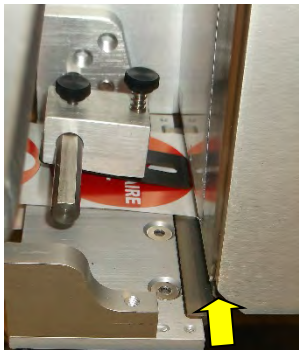
For parts pricing and availability, call QLC, Inc. (800) 837-1309

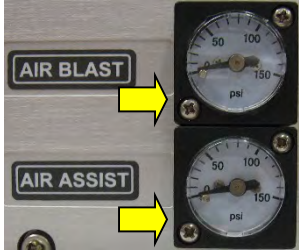
3111NV/CE SPARE PARTS CIRCUIT BOARDS & ELECTRICAL					
NO	PART NO.	DESCRIPTION	QTY	ASSEMBLY PHOTO	DETAIL PHOTO
59	0031024	ASY/WRNG CBL KB/DSPL INTL	1		
60	0031023	ASY/WRNG CBL CNTRL/STATUS	1		
61	3301410	PANEL I/O ELECT MDL V-2	1		

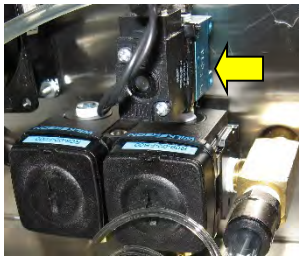
For parts pricing and availability, call QLC, Inc. (800) 837-1309



3111NV/CE SPARE PARTS MECHANICAL PARTS					
NO	PART NO.	DESCRIPTION	QTY	ASSEMBLY PHOTO	DETAIL PHOTO
62	L052995	ASY AIR ASSIT TUBE W/BRKT & SCREWS 7"	1		
63	3301335	AIR ASSIT TUBE 7"	1		
64	7700933AP	GAUGE 0-150 PSI FLUSH MT	2		
65	7705748	VALVE 24VDC 1/8 NPT 3-WAY AIR ASSIST	1		

For parts pricing and availability, call QLC, Inc. (800) 837-1309





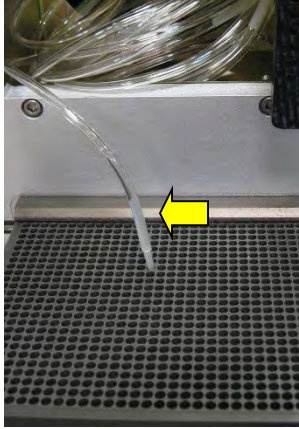
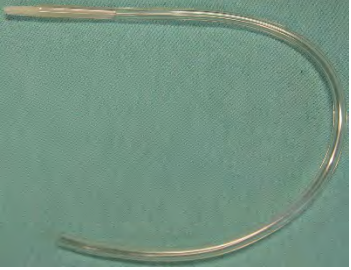
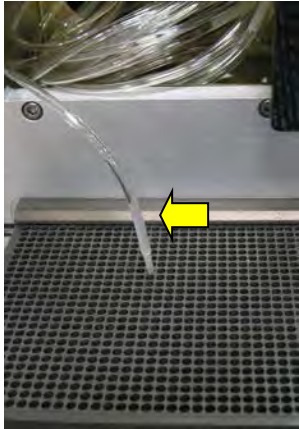

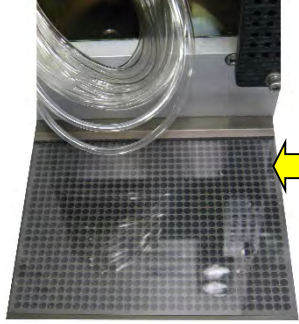
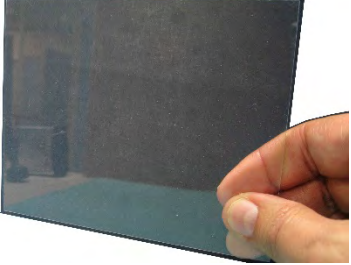
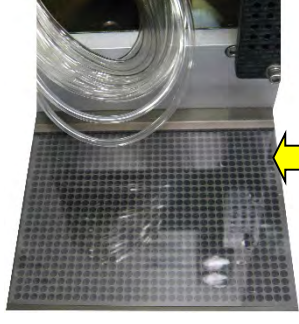
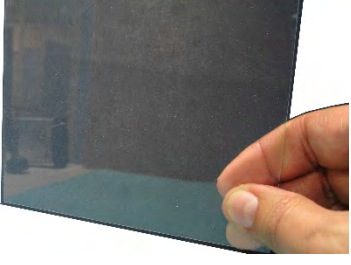

3111NV/CE SPARE PARTS MECHANICAL PARTS					
NO	PART NO.	DESCRIPTION	QTY	ASSEMBLY PHOTO	DETAIL PHOTO
66	7700934	REGULATOR AIR BLAST	1		
67	7700924AP	REGULATOR AIR ASSIST	1		
68	7705747	VALVE 24VDC 1/4 NPT 4-WAY AIR BLAST	1		
69	7481303	ASY AIR JET MFLD/AIR TUBE 11" L (WITH INSERT AIR JET)	1		

For parts pricing and availability, call QLC, Inc. (800) 837-1309

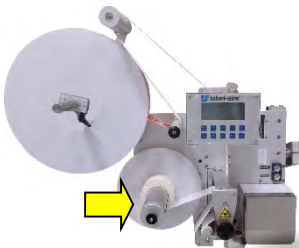



**3111NV/CE SPARE PARTS
MECHANICAL PARTS**

NO	PART NO.	DESCRIPTION	QTY	ASSEMBLY PHOTO	DETAIL PHOTO
70	7481802	TUBE ASY 11" (WITH INSERT AIR JET)	18		
71	7482000	INSERT AIR JET	18		
72	7451360SP	GRID INSERT PLT 5.47X 4.31	1		
73	7451361AP	GRID INSERT PLT 6.31X 5.47	1		



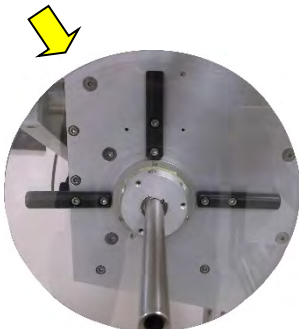
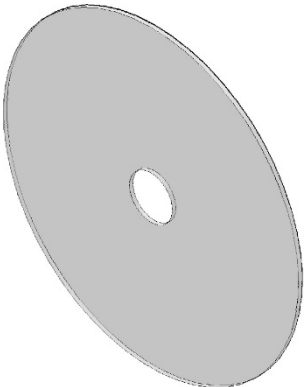
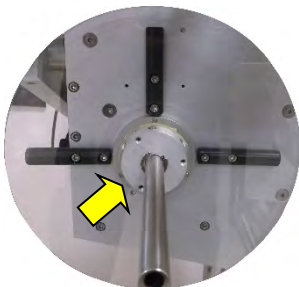
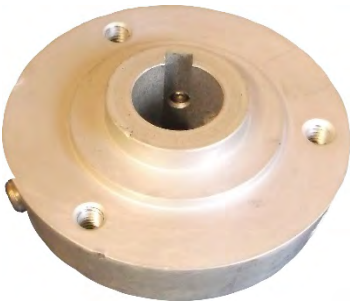
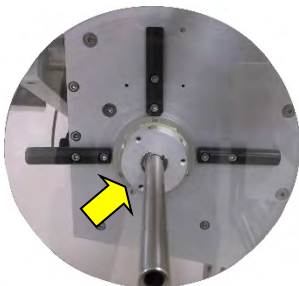

For parts pricing and availability, call QLC, Inc. (800) 837-1309

3111NV/CE SPARE PARTS MECHANICAL PARTS					
NO	PART NO.	DESCRIPTION	QTY	ASSEMBLY PHOTO	DETAIL PHOTO
74	7481900	FILTER 1/4 NPT	1		
75	3302072SP	ASY MANDREL REWIND 7"	1		
76	7706471	PIN QUICK RELEASE BALL LOCK	1		
77	7700473	COLLAR SPLIT 2 PC 0.375 ID SS	1		





For parts pricing and availability, call QLC, Inc. (800) 837-1309

3111NV/CE SPARE PARTS MECHANICAL PARTS					
NO	PART NO.	DESCRIPTION	QTY	ASSEMBLY PHOTO	DETAIL PHOTO
78	3309056	RAIL RWD DISC SUPPORT	4		
79	3362317	DISK RWD 10.5	1		
80	7210201	ASY HUB CLPSE RWD MANDREL WITH SET SCREWS AND DOWELS	1		
81	7432100	SNAP RING E-RING EXTL 0.625 SS	1		

For parts pricing and availability, call QLC, Inc. (800) 837-1309

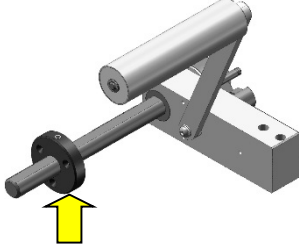
3111NV/CE SPARE PARTS MECHANICAL PARTS					
NO	PART NO.	DESCRIPTION	QTY	ASSEMBLY PHOTO	DETAIL PHOTO
82	3301045SP	ASY IDLER ROLLER DANCER UNWD 7	1		
83	3305044SP	ASY UNWD DISK 16" INR AL	1		
84	3306176	ASY UNWD DISK 16" OUTER LEXAN W/MTG BLK AND KIP HANDLE	1		
85	7702131	DISK HANDLE	1		

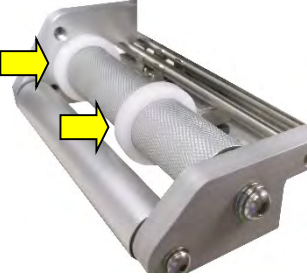
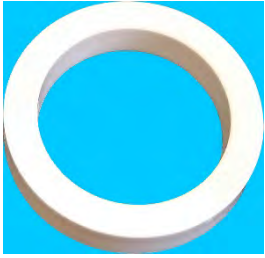
For parts pricing and availability, call QLC, Inc. (800) 837-1309

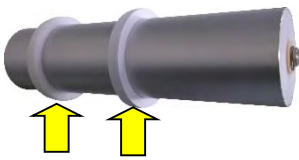
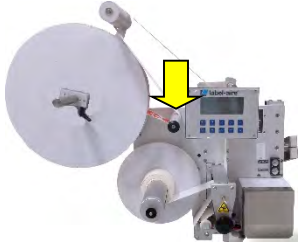
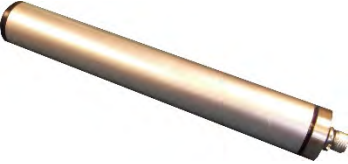
3111NV/CE SPARE PARTS MECHANICAL PARTS					
NO	PART NO.	DESCRIPTION	QTY	ASSEMBLY PHOTO	DETAIL PHOTO
86	7470905	HUB INNER UNWIND W/SET SCREW	1		
87	3301077	COLLAR GUIDE (1" DIA ROLLER)	2		
88	7472410	COLLAR GUIDE (1.25" DIA ROLLER)	4		
89	7212010	COLLAR GUIDE (2" DIA ROLLER)	2		
90	3301017SP	ASY IDLER ROLLER 7"	1		







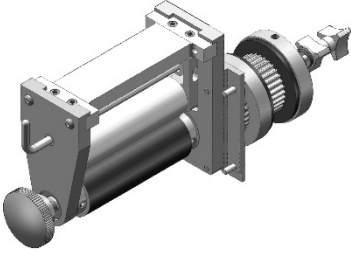
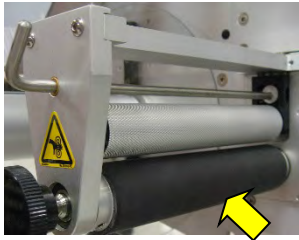

For parts pricing and availability, call QLC, Inc. (800) 837-1309

3111NV/CE SPARE PARTS MECHANICAL PARTS					
NO	PART NO.	DESCRIPTION	QTY	ASSEMBLY PHOTO	DETAIL PHOTO
91	7482401	TUBING 1/4 X 100 FT POLYTHN (AIR ASSIST) (SOLD BY THE INCH)	in		
92	7700589	TUBING 3/8 X 100 FT ROLL (VAC BOX GRID) (SOLD BY THE INCH)	in		
93	7700597	TUBING CLEAR 1/16ID POLYURETHN (AIR GAUGES) (SOLD BY THE INCH)	in		
94	3301009SP	MAIN DRIVE PULLEY W/SET SCREWS	1		

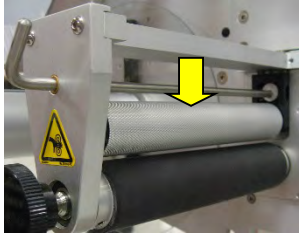
For parts pricing and availability, call QLC, Inc. (800) 837-1309

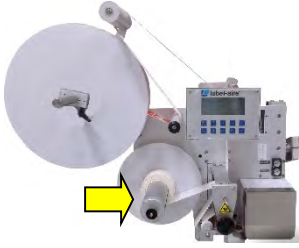
3111NV/CE SPARE PARTS MECHANICAL PARTS					
NO	PART NO.	DESCRIPTION	QTY	ASSEMBLY PHOTO	DETAIL PHOTO
95	7700951AP	RETRO PRODUCT DETECTOR REFLECTOR TAPE (1" W X 4.5" L)	1		

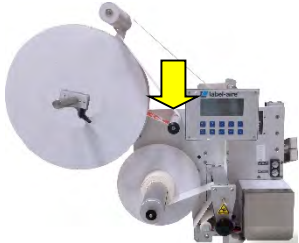
For parts pricing and availability, call QLC, Inc. (800) 837-1309

3111NV/CE SPARE PARTS 4 INCH PARTS					
NO	PART NO.	DESCRIPTION	QTY	ASSEMBLY PHOTO	DETAIL PHOTO
96	3303750	ASY MAIN DRIVE 4"	1		
97	3301053SP	ASY ROLLER DRIVE 4" W/SET SCREWS	1		
98	3302059SP	ASY PINCH ROLL MAIN DRIVE 4"	1		
99	3302071SP	ASY MANDREL REWIND 4"	1		
100	3301035SP	ASY IDLER ROLLER 4"	1		

For parts pricing and availability, call QLC, Inc. (800) 837-1309

3111NV/CE SPARE PARTS 4 INCH PARTS					
NO	PART NO.	DESCRIPTION	QTY	ASSEMBLY PHOTO	DETAIL PHOTO
101	P177425	ASY IDLER ROLLER DANCER UNWD 4"	1		
102	3303283	P/B TIP 4" HRD 0.025R	1		
103	3301441SP	ASY AIR ASSIT TUBE W/BRKT & SCREWS 4"	1		
104	3301146	AIR ASSIT TUBE 4"	1		

For parts pricing and availability, call QLC, Inc. (800) 837-1309